

# AN ANALYTICAL PROCEDURE FOR RC BEAMS STRENGTHENED BY NEW CONCRETE LAYERS

Ourania T. Tsioulou  
Civil Engineer, MSc.  
Dept. of Civil Engineering  
University of Patras  
Greece

Stefanos E. Dritsos  
Associate Professor  
Dept. of Civil Engineering  
University of Patras  
Greece  
[dritsos@upatras.gr](mailto:dritsos@upatras.gr)

## ABSTRACT

A common problem in high seismicity areas is the need for flexural strengthening of the weak reinforced concrete elements. A popular technique for increasing the flexural capacity of reinforced concrete elements involves the casting of a new concrete layer, reinforced or not, on the tensile or the compressive side of the element. Slip at the interface between the old and the new concrete affects the behaviour of the composite element. However, it is common practice in design to ignore slip and consider the strengthened element as monolithic. In the present paper, an approximate estimation of the maximum values of sliding, slip strain and shear stress of the strengthened element is presented. In addition, an analytical procedure for prediction of the distribution of sliding and slip strain along the interface between the initial beam and the new layer of concrete is presented. Finally, the results of these two methods are compared.

**KEYWORDS:** strengthened concrete beams, new concrete layers, interface, shear stress, slip strain and sliding.

## INTRODUCTION AND BACKGROUND

Many existing reinforced concrete structures, especially in high seismicity areas, require flexural strengthening of their weak elements. The addition of a new concrete layer on the compressive or the tensile side of an element is a very common practice. In the literature, there is little experimental data on the strengthening of beams by the addition of a new concrete layer (Vassiliou, 1975; Trikha et al., 1991; Zervos and Beldekas, 1995; Cheong and MacAlevey, 2000; Altun, 2004).

An element strengthened with an additional concrete layer is a composite element and its behaviour depends on the connection between the old and the new concrete. Figure 1 presents strain distributions for various cases of strengthening in the tensile region. If the connection is perfect, which is the aim when strengthening, there is no slip at the interface between the new and the old concrete and the composite element behaves as a monolithic element. In this case, the strain distribution against height of cross section is continuous, as can be seen in figure 1a. If there is no connection at the interface, the old and the new concrete behave independently and the strain distribution for this case is shown in figure 1b.

In reality, the behaviour of the composite element is somewhere between the two above cases. The slip between the two layers is related to the shear stress at the interface and, in this situation, there are three types of strain distribution with height of cross section. The first type of strain distribution occurs when only a part of the old concrete element is in the compression zone, as shown in figure 1c. When all of the old concrete and a part of the new concrete are in the compression zone, the strain distribution is as shown in figure 1d. The last type of strain distribution occurs when the compression zone includes part of the old concrete and part of the new concrete as shown in figure 1e.

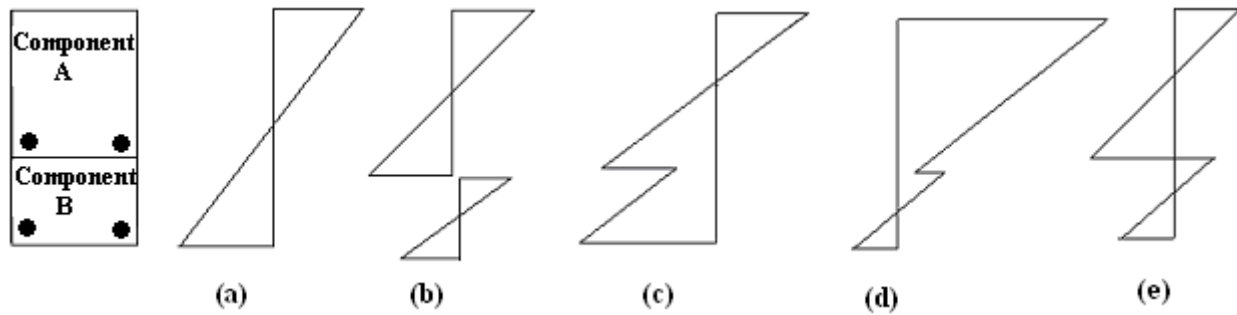

Figure 1. Strain distribution profiles for different connection conditions at the interface of a strengthened element a) perfect connection, b) no connection c), d) and e) partial connection.

From the above considerations, it is obvious that the condition of the connection at the interface is very important for the behaviour of the strengthened element. For analysis, a shear transfer model should be used to simulate the connection condition. In the literature, there are many models for shear load transfer. Most of them give a relationship between shear stress and sliding,  $s$ , by following relevant models for the shear transfer at the interface that occurs in cracks in concrete (Vintzeleou, 1984; Tassios and Tsoukantas, 1989; Tassios and Vintzeleou, 1990; Tassios, 2003; Nie et al., 2004; GRECO 2005). Others use a relationship between the shear stress and the slip strain,  $\varepsilon_L$ , (Saidi et al., 1990; Kotsira et al., 1993; Dritsos, 1994; Dritsos and Pilakoutas, 1995). Other relevant analytical studies can be found in the literature that considers the interface slip of composite steel concrete beams (Nie and Cai, 2003; Nie et al., 2004).

Analytical procedures for the capacity evaluation of strengthened beams have been presented in the past (Saidi et al., 1990; Kotsira et al., 1993; Dritsos, 1994; Dritsos, 1996; Nie and Cai, 2003; Nie et al., 2004). They consider the equilibrium between applied moments and internal forces acting in the cross section of the beam. In addition, they consider the equilibrium of the old and new concrete elements separately and take into account a shear force against sliding model at the interface.

In a previous study (Lampropoulos et al., 2004), a computer programme called ACESCL (Analysis Concrete Element Strengthened by Concrete Layers) was developed based on analytical work presented by Dritsos (1994). This program used the following two assumptions: a) the old and the new concrete had the same curvature and b) the relationship between the average value of shear stress along the beam and the slip strain at the mid span was linear. By using the above software, the strength and the slip strain at the mid span of the composite element could be calculated. However, no information could be obtained regarding the distribution of sliding along the interface between the two components. In the present paper, an analytical procedure that predicts the distribution of sliding and slip strain along the interface between the initial beam and the additional concrete layer is presented for a simply supported beam.

## PREDICTING THE DISTRIBUTION OF SLIDING ALONG THE INTERFACE

### (1) Approximate estimation of maximum sliding, maximum slip strain and maximum shear stress

For a simply supported symmetrically loaded beam with span length  $l$ , the boundary conditions are as follows: The sliding at mid span and the slip strain at the supports equal zero ( $s_m = 0$  and  $\varepsilon_{L,A,B} = 0$ ).

Obviously, the maximum sliding occurs at the supports A and B for a centrally loaded simply supported beam and can be approximately estimated by the following equation:

$$s_A = s_B = \bar{\varepsilon}_L \cdot \frac{l}{2} = \frac{\varepsilon_{Lm}}{2} \cdot \frac{l}{2} = \frac{\varepsilon_{Lm} \cdot l}{4} \quad (1)$$

Where:  $\bar{\varepsilon}_L$  is the average value of slip strain from the support to the mid span and

$\varepsilon_{Lm}$  is the slip strain at the mid span of the beam.

The slip strain at mid span of the composite beam can be evaluated by using the computer programme ACESCL (Lampropoulos et al., 2004). Furthermore:

$$\bar{\tau} = \frac{\tau_A + \tau_m}{2} = \frac{\tau_A}{2} \quad (2)$$

By assuming that the average shear stress,  $\bar{\tau}$ , at the interface is given by the equation  $\bar{\tau} = K \cdot \varepsilon_{L,m}$  and, by using equations (1) and (2), the shear stress at the supports is given by the following equation:

$$\tau_A = \tau_B = 8 \cdot K \cdot \frac{S_A}{l} \quad (3)$$

## (2) Analytical procedure for determining the distribution of sliding and slip strain along the interface of a strengthened beam

The computer program ACESCL assumed a linear relationship between the average value of shear stress and the slip strain at the mid span ( $\bar{\tau} = K \cdot \varepsilon_{L,m}$ ) and, as a result, the computer program required the input of reliable values for coefficient K. In the literature (Vintzeleou, 1984; Tassios and Tsoukantas, 1989; Tassios and Vintzeleou, 1990; Tassios, 2003; Dritsos, 2001; GRECO 2005), shear stress is commonly given by shear stress against sliding curvatures and more simply by the equation  $\tau(x) = K_s \cdot s(x)$ , where  $s(x)$  is the sliding at the interface,  $\tau(x)$  is the shear stress at the interface of a specific section and coefficient  $K_s$  depends on the connection conditions at the interface of the strengthened beam.

With the assumption that the relationship between shear stress and sliding is given by the following equation (Tassios and Tsoukantas, 1989; Tassios and Vintzeleou, 1990; Tassios, 2003; Dritsos, 2001; GRECO, 2005):

$$\tau = K_s \cdot s \quad (4)$$

the shear stress at support A ( $\tau_A$ ) is given by  $\tau_A = K_s \cdot s_A$

By comparing equations 3 and 4, it can be seen that:

$$K = (l / 8) \cdot K_s \quad (5)$$

For a centrally loaded simply supported beam with span length  $l$ , height  $h$  and width  $b$ , the strain distribution is given by figure 2.

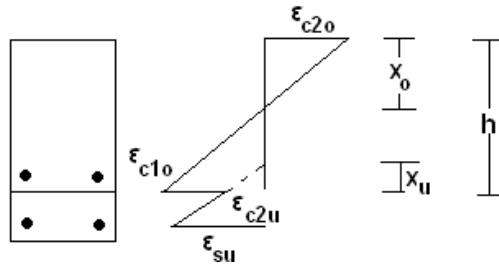

Figure 2. Strain distribution of a strengthened beam.

By assuming that the curvature for the initial beam and new concrete layer are the same, the following equation can be produced.

$$\varepsilon_L = \varepsilon_{c1o} - \varepsilon_{c2u} = (h - x_o - x_u) \cdot \phi \quad (6)$$

However, equation 6 is only valid at the mid span of the beam.

For any other section, the respective equation is as follows:

$$\varepsilon_L(x) = (h - x_o - x_u)(x) \cdot \phi(x) \quad (7)$$

For a centrally loaded simply supported beam, the bending moment at a distance  $x$  from the support is given the following equation:

$$M = \frac{P}{2}x \quad (8)$$

Let  $\Delta_o = (h - x_o - x_u) = \Delta(l / 2)$ , then  $\varepsilon_L(0) = 0 \Rightarrow \Delta(0) = 0$ .

It can be assumed that the distribution of  $\Delta$  along the length of the beam is linear and is given by the following equation:

$$\Delta(x) = \Delta_o \cdot 2x / l \quad (9)$$

Figure 3 presents a bilinear idealization of the bending moment against curvature ( $M-\phi$ ) plot. From figure 3, two different cases can be distinguished, as follows: a) the examined section before yielding,  $x \leq x_y$  and b) the examined section after the yielding,  $x \geq x_y$ .

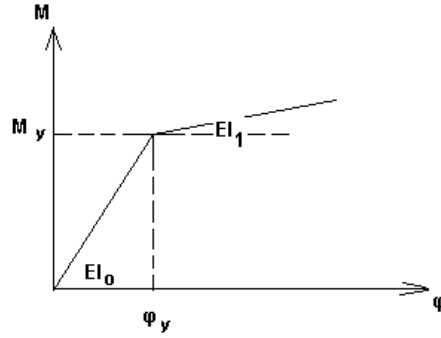

Figure 3. Bilinear idealization of the bending moment against curvature plot.

In figure 3,  $EI_o$  is the elastic stiffness of the strengthened beam and  $EI_1$  is the inelastic stiffness of the strengthened beam. Figure 4 presents the bending moment distribution along the beam.

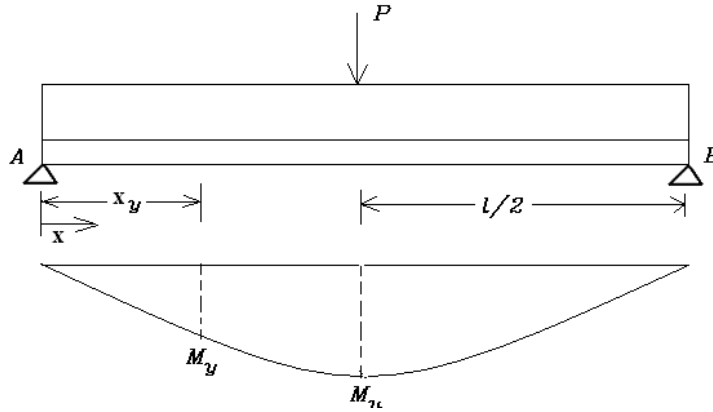

Figure 4. Bending moment distribution along the beam.

When  $x < x_y$ , the equation of curvature is as follows:

$$\phi(x) = \frac{M(x)}{EI_o} \quad (10)$$

and slip strain is given by:

$$\varepsilon_L(x) = (\Delta)(x) \cdot \frac{P \cdot x}{2 \cdot EI_o} \Rightarrow \varepsilon_L(x) = \frac{\Delta_o \cdot P \cdot x^2}{EI_o \cdot l} \quad (11)$$

Therefore, the sliding can be obtained from:

$$s(x) = \int \varepsilon_L(x) dx \Rightarrow s(x) = \frac{\Delta_o \cdot P}{3 \cdot EI_o \cdot l} \cdot x^3 + c \quad (12)$$

and the force at the interface is given by the following equation:

$$F_{\tau_1}(x) = k_s \cdot b \cdot \int s(x) dx \Rightarrow F_{\tau_1}(x) = k_s \cdot b \cdot \left( \frac{\Delta_o \cdot P}{12 \cdot EI_o \cdot l} \cdot x^4 + c \cdot x + c1 \right) \quad (13)$$

At the support of the beam, the bending moment equals zero and, as a result, the force at the interface,  $F_{\tau}$ , also equals zero.

By using the boundary conditions at the supports ( $M(0) = 0$  and  $F_\tau = 0$ ) the following equations can be produced:

$$\varepsilon_L(0) = 0$$

and

$$F_\tau(0) = 0 \Rightarrow c_1 = 0$$

When  $x_y \leq x \leq l/2$  and from figure 3, it is obvious that:

$$EI_1 = \frac{M - M_y}{\phi - \phi_y} \text{ and, if it is assumed that } \phi_1 = \phi_y - \frac{M_y}{EI_1}, \text{ the following equation for curvature at}$$

any section  $x$  with  $x_y \leq x \leq l/2$  can be obtained:

$$\phi = \phi_1 + \frac{M}{EI_1} \quad (14)$$

Moreover,  $M = \frac{P}{2}x$  and therefore:

$$\phi(x) = \phi_1 + \frac{P}{2 \cdot EI_1} \cdot x \quad (15)$$

By replacing the curvature in equations 11 and 12 with equation 15, the following equations for sliding and slip strain can be produced:

$$s(x) = \frac{\Delta_o \cdot P}{3 \cdot EI_o \cdot l} x_y^3 + \frac{\Delta_o \cdot P}{3 \cdot EI_1 \cdot l} (x^3 - x_y^3) + \frac{\Delta_o \cdot \phi_1}{l} (x^2 - x_y^2) + c \quad (16)$$

and

$$\varepsilon_L(x) = \frac{\Delta_o \cdot P}{EI_1 \cdot l} \cdot x^2 + \frac{2 \cdot \Delta_o \cdot \phi_1}{l} \cdot x \quad (17)$$

By using the boundary conditions at mid span ( $s(l/2) = 0$ ), the following equations can be determined:

$$c = \frac{\Delta_o \cdot P}{3 \cdot EI_1 \cdot l} \cdot x_y^3 + \frac{\Delta_o \cdot \phi_1}{l} \cdot x_y^2 - \frac{\Delta_o \cdot P}{3 \cdot EI_o \cdot l} \cdot x_y^3 - \frac{\Delta_o \cdot P \cdot l^2}{24 \cdot EI_1} - \frac{\Delta_o \cdot \phi_1 \cdot l}{4} \quad (18)$$

$$F_\tau(x) = k_s \cdot b \cdot \left[ \frac{\Delta_o \cdot P}{12 \cdot EI_o \cdot l} \cdot (x^4 - x_y^4) + \frac{\Delta_o \cdot \phi_1}{3 \cdot l} \cdot (x^3 - x_y^3) + \left( \frac{\Delta_o \cdot P}{3 \cdot EI_o \cdot l} \cdot x_y^3 - \frac{\Delta_o \cdot P}{3 \cdot EI_1 \cdot l} \cdot x_y^3 - \frac{\Delta_o \cdot \phi_1}{l} \cdot x_y^2 + c \right) \cdot (x - x_y) + \frac{P \cdot \Delta_o}{12 \cdot EI_o \cdot l} \cdot x_y^4 + c \cdot x_y \right] \quad (19)$$

The above calculations can be summarised by the following equations:

$$\varepsilon_L(x) = \begin{cases} \frac{\Delta_o \cdot P}{EI_o \cdot l} \cdot x^2, & 0 \leq x \leq x_y \\ \frac{\Delta_o \cdot P}{EI_1 \cdot l} \cdot x^2 + \frac{2 \cdot \Delta_o \cdot \phi_1}{l} \cdot x, & x_y \leq x \leq l/2 \end{cases} \quad (20)$$

$$s(x) = \begin{cases} \frac{\Delta_o \cdot P}{3 \cdot EI_o \cdot l} \cdot x^3 + c, & 0 \leq x \leq x_y \\ \frac{\Delta_o \cdot P}{3 \cdot EI_o \cdot l} \cdot x_y^3 + \frac{\Delta_o \cdot P}{3 \cdot EI_1 \cdot l} \cdot (x^3 - x_y^3) + \frac{\Delta_o \cdot \phi_1}{l} \cdot (x^2 - x_y^2) + c, & x_y \leq x \leq l/2 \end{cases} \quad (21)$$

and

$$F_{\tau}(x) = \begin{cases} k_s \cdot b \cdot \left( \frac{\Delta_o \cdot P}{12 \cdot EI_o \cdot l} \cdot x^4 + c \cdot x \right), & 0 \leq x \leq x_y \\ k_s \cdot b \cdot \left( \frac{\Delta_o \cdot P}{12 \cdot EI_o \cdot l} \cdot x_y^4 + c \cdot x_y \right) + \frac{\Delta_o \cdot P}{12 \cdot EI_o \cdot l} \cdot (x^4 - x_y^4) + \frac{\Delta_o \cdot \phi_1}{l} \cdot (x^3 - x_y^3) \\ \quad + \left( \frac{\Delta_o \cdot P}{3 \cdot EI_o \cdot l} \cdot x_y^3 - \frac{\Delta_o \cdot P}{3 \cdot EI_1 \cdot l} \cdot x_y^3 - \frac{\Delta_o \cdot \phi_1}{l} \cdot x_y^2 + c \right) \cdot (x - x_y), & x_y \leq x \leq l/2 \end{cases} \quad (22)$$

All the variables of the above equations are known and the above equations can be used in the computer program ACESCL (Lampropoulos et al., 2004). Therefore, for different values of x, the sliding (s), the slip strain ( $\epsilon_L$ ) and the shear stress ( $\tau = K_s \cdot s$ ) can be determined.

### (3) A numerical example

In the following, a numerical application of the previous analytical procedure is presented. A strengthened concrete beam used in a previous study (Lampropoulos et al., 2004) is further analysed to evaluate the sliding, slip strain and shear stress distribution along the interface. The cross sectional dimensions of the initial beam were 130 mm by 70 mm and the span length was 750 mm. The longitudinal tensile reinforcement was two 6 mm diameter bars of steel grade S400 and the concrete cover was 10 mm. The thickness, t, of the additional layer was 20 mm and the reinforcement was two 6 mm diameter bars of steel grade S400. The concrete cover was again 10 mm. The concrete strength of both the beam and the new layer was considered to equal 25 MPa and the ultimate compressive strain was considered to equal 0.35%. An increment load was applied at mid span. The dimensions, loading conditions and cross section of the strengthened beam are presented in Fig. 5.

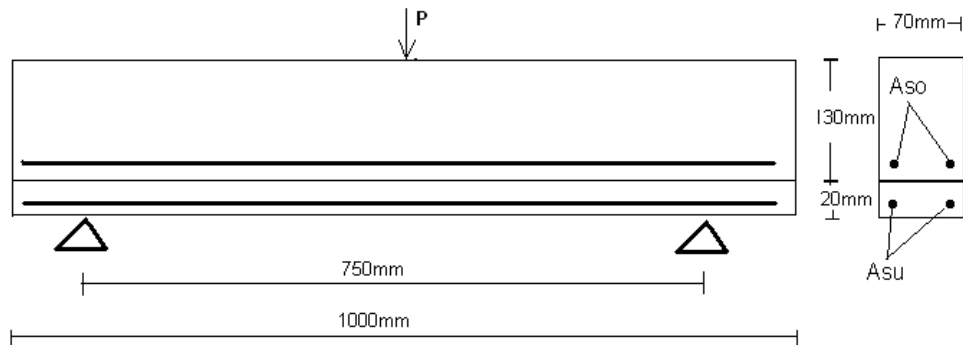

Figure 5. Geometry and loading conditions of the strengthened beam.

In the previous analytical work (Lampropoulos et al., 2004), the slip strain and the sliding at mid span of the beam were calculated by assuming that  $K$  equalled 600 MPa. The slip strain and the mean value of shear stress were found to equal 0,16% and 0.96 Mpa respectively. Therefore, for the analytical procedure it was assumed that  $K_s = (8/l) \cdot K \Rightarrow K_s = 64 \cdot 10^8 \text{ N/m}^3$ . It was also assumed that the point of steel yield ( $x_y$ ) for the strengthened and the respective monolithic beams were the same and that  $EI_1$  equals  $EI_o/10$ . By using equations 20, 21 and 22, distributions of sliding, slip strain and shear stress along the interface of the beam can be calculated.

As far as the approximate estimation of the maximum sliding, slip strain and shear stress is concerned from equations 1, 2 and 3, the following results can be obtained:

By using equation 1, the sliding at supports A and B can be calculated as follows:

$$s_A = s_B = \frac{\epsilon_{Lm} \cdot l}{4} = \frac{0,0016 \cdot 0,75}{4} = 0,0003\text{m} = 0,3\text{mm}$$

and from equation 2, the shear stress at the supports can also be calculated as follows:

$$\bar{\tau} = \frac{\tau_A + \tau_m}{2} = \frac{\tau_A + 0}{2} \Rightarrow 0,96 = \frac{\tau_A}{2} \Rightarrow \tau_A = 1,92\text{MPa} = \tau_B$$

The results from both the above methodologies are given in figures 6, 7 and 8 for the respective sliding, slip strain and shear stress distribution along the interface of the strengthened beam.

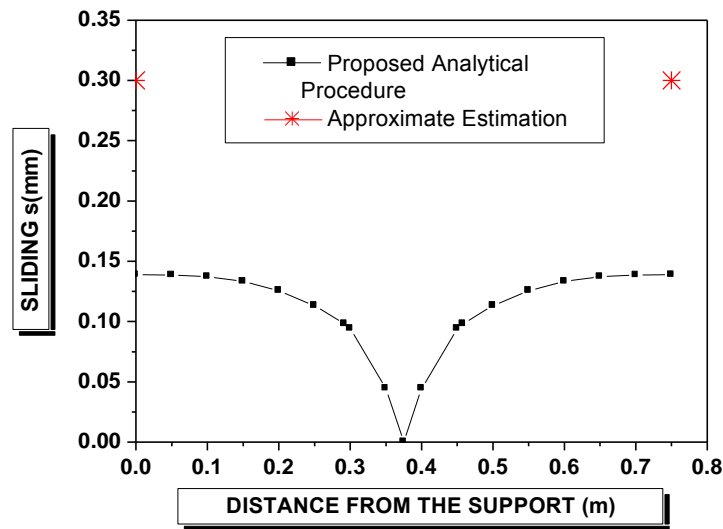

Figure 6. Distribution of sliding along the interface of the strengthened beam.

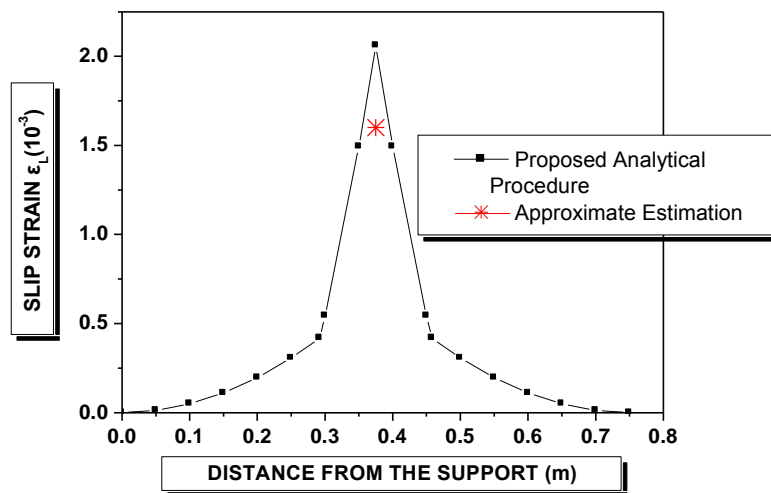

Figure 7. Distribution of slip strain along the interface of the strengthened beam.

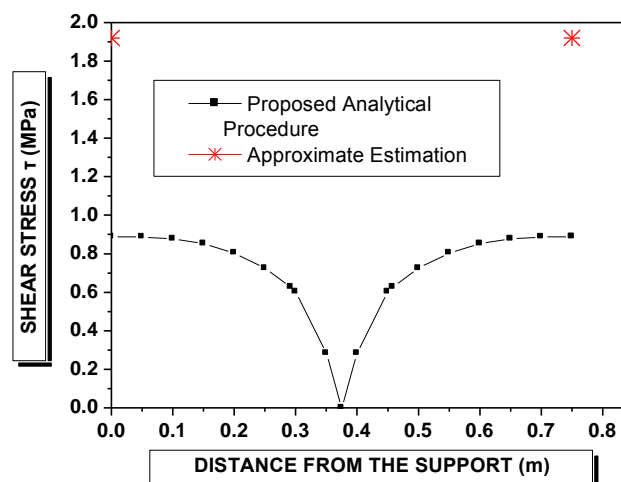

Figure 8. Distribution of shear stress along the interface of the strengthened beam.

From figures 6 and 8, it is obvious that the distributions of sliding and shear stress along the interface of the beam from equations 20 and 22 are almost parabolic with maximum values at the supports and minimum values at the mid span where  $\tau$  equals 0.00 MPa and  $s$  equals 0.00 mm. Moreover, from the distribution of slip strain along the interface from equation 21 and figure 7, it is obvious that the slip strain achieves its maximum value at the mid span and its minimum value at the supports of the beam where  $\varepsilon_L$  equals zero.

Furthermore, when comparing the two methods, it is obvious that the approximate equations give greater values (almost double) than the analytical procedure for sliding and shear stress while, for the maximum slip strain, the values from both methods are very close. There is a difference in maximum value of the slip strain at mid span between the analytical procedure and the approximate estimation and this would be due to the assumption that  $K_s = (8/l) \cdot K$ .

## CONCLUSIONS

According to the present study for typical central loaded simply supported concrete beams strengthened by placing a new concrete layer, there is a relationship between slip strain and sliding at the interface which is given approximately by equation 5. In addition, a more accurate procedure for calculating the distribution of sliding, shear stress and slip strain along the length of the interface has been presented. Through this procedure, the distribution of sliding and shear stress along the interface of the beam was found to be almost parabolic with maximum values at the supports and a minimum value at mid span where  $\tau$  equals 0.00 MPa and  $s$  equals 0.00 mm. In addition, from the distribution of slip strain along the interface, it is obvious that the maximum slip strain occurs at mid span and its minimum value is at the supports of the beam where  $\varepsilon_L$  is equal to zero. Finally, when comparing the two methods, it is obvious that approximate equations give greater values for sliding and shear stress but, when considering the maximum slip strain, the values from both methods are very close.

## ACKNOWLEDGEMENTS

The contribution of Dr. J. Moseley to the preparation of this manuscript is greatly acknowledged.

## REFERENCES

- Altun, F. (2004), "An Experimental Study of Jacketed Reinforced Concrete Beams Under Bending", *Construction and Building Materials*, Vol. 18, pp. 611-618.
- Cheong, H. K. and MacAlevey, N. (2000), "Experimental Behaviour of Jacketed Reinforced Concrete Beams", *ASCE Journal of Structural Engineering*, Vol. 126, pp. 692-699.
- Dritsos, S. (1994), "Ultimate Strength of Flexurally Strengthened RC members", 10<sup>th</sup> European Conference on Earthquake Engineering, Vol. 3, pp. 1637-1642, Vienna.
- Dritsos, S. (2001), "Repair and Strengthening of Reinforced Concrete Structures", University of Patras, Patras, Greece. (In Greek).
- Dritsos, S. and Pilakoutas, K. (1995), "Strengthening of RC elements by New Concrete Layers", *Proc. of the 5<sup>th</sup> SECED Conference: European Seismic Design Practice*, pp. 611-617, Chester.
- GRECO (2005), Second Draft Version, "Greek Retrofit Code", by the Greek Organization for Seismic Planning and Protection, Greek Ministry for Environmental Planning and Public Works, Athens. (In Greek).
- Kotsira, E., Dritsos, S. and Pilakoutas, K. (1993), "Effectiveness of Techniques for Flexural Repair and Strengthening of RC Members", *Proc. of the 5<sup>th</sup> International Conference on Structural Faults and Repair*, Vol. 3, pp. 235-243, Edinburgh.
- Lampropoulos, A., Tsioulou, O. and Dritsos, S. (2004), "Analytical prediction of the behaviour of R.C. strengthened beams", *International Symposium: Durability and Maintenance of Concrete Structures*, Paper N<sup>o</sup>. 78, pp. 675-682, Dubrovnik.
- Nie, J. and Cai, C. (2003), "Steel-Concrete Composite Beams Considering Shear Slip Effects", *Journal of Structural Engineering*, ASCE, Vol. 129 (4), pp 495-506.



Nie, J., Fan, J. and Cai, C. (2004), "Stiffness and Deflection of Steel-Concrete Composite Beams under Negative Bending", *Journal of Structural Engineering, ASCE*. Vol. 130 (11), pp 1842-1851.

Saidi, M., Vrontinos, S. and Douglas, B. (1990), "Model for the Response of Reinforced Concrete Beams Strengthened by Concrete Overlays", *Structural Journal, ACI*, Vol. 87, pp 687-695.

Tassios, T. (2003), "Strengthening and Rehabilitation Design Theory", National Technical University of Athens, Athens.

Tassios, T. and Tsoukantas, S. (1989), "Shear Resistance of Connections between Reinforced Concrete Linear Precast Elements", *Structural Journal, ACI*, Vol. 86.

Tassios, T. and Vintzeleou, E. (1990), "Shear Crack Stability along a Precast Reinforced Concrete Joint", *International Workshop: Applications of Fracture Mechanics to Reinforced Concrete*, Torino.

Trikha, D., Jain, S. and Hali, S. (1991), "Repair and Strengthening of Damaged Concrete Beams", *Concrete International: Design and Construction*, pp. 53-59.

Vassiliou, G. (1975), "An Investigation of the Behaviour of Repaired RC Elements Subjected to Bending", PhD Thesis, NTU, Athens. (In Greek).

Vintzeleou, E. (1984), "Load Transfer Mechanisms Along Reinforced Concrete Interfaces under Monotonic and Cyclic Actions", PhD Thesis, National Technical University of Athens, Athens. (In Greek).

Zervos, N. and Beldekas, V. (1995), "An Experimental Investigation on Strengthening of RC Beams by Additional RC Overlays", Dissertation Thesis, Department of Civil Engineering, University of Patras, Patras. (In Greek).